

LITTLE JOE PARTS LIST

NEWCO ENTERPRISES INC,
3650 NEW TOWN BLVD SAINT CHARLES, MO 63301
1-800-325-7867



For brewer PN 153000

NEWCO
newcocoffee.com 

Technical Service: 1-800-556-3926

NEWCO CONTACT INFORMATION

ADDRESS

NEWCO ENTERPRISES INC,
3650 NEW TOWN BLVD SAINT CHARLES, MO 63301

CUSTOMER SERVICE PHONE

1-800-325-7867

TECHNICAL SERVICE PHONE

1-800-556-3926

FAX

1-636-925-0029

WEBSITE

newcocooffee.com

CUSTOMER SERVICE AND SALES EMAIL

sales@newcocooffee.com

MAINTENANCE INFORMATION

Machine Model _____

Company Information and Phone Number

TABLE OF CONTENTS

WARRANTY-----	4
SERVICING YOUR MACHINE	
DRAINING THE WATER -----	5
FLAVOR RING INSTRUCTIONS -----	6
MACHINE PARTS -----	10
DISPLAY -----	11
DISPLAY ASSEMBLY WITH PANEL-----	12
WASTE BIN-----	13
DRIP TRAY -----	14
DRAIN TUBE-----	15
RESERVOIR -----	16
BREWING MECHANISM-----	17
DISPENSE AREA-----	18
BACK OF THE MACHINE-----	19
WATER INLET-----	20
TANK WITH MAJOR COMPONENTS -----	21
3-WAY VALVE ASSEMBLY COMPONENTS -----	22
RIGHT SIDE -----	23
WIRING DIAGRAM -----	24

WARRANTY

This warranty supersedes all other previous warranties that are currently in manuals. Newco warrants equipment manufactured by it for 1 year parts and labor. Dispensers and Display Tablets - 1 year parts only. Electronic Circuit and Control Boards- 1 year parts and labor.

These warranty periods run from the date of sale Newco warrants that the equipment manufactured by it will be commercially free of defects in material and workmanship existing at the time of manufacture and appearing within the applicable warranty period. This warranty does not apply to any equipment, component or part that was not manufactured by Newco or that, in Newco's judgment, has been affected by misuse, neglect, alteration, improper installation or operation, relocation or reinstallation, improper maintenance or repair, incorrect voltage applied to the unit at any time, damage or casualty. This warranty does not apply to any equipment failures related to poor water quality, excessive lime and chlorine and non-periodic cleaning and descaling. Warranty is null and void if muriatic or any other form of hydrochloric acid is used for cleaning or deliming. In addition, this warranty does not apply to replacement of items subject to normal use including but not limited to user replaceable parts such as faucet seat cups, sight gauge tubes, washers, o-rings, tubing, seals and gaskets.

This warranty is conditioned on the Buyer 1) giving Newco prompt notice of any claim to be made under this warranty by telephone at (800) 556-3926 or by writing to **3650 New Town Blvd, Saint Charles, MO 63301**; 2) if requested by Newco, shipping the defective equipment prepaid to an authorized Newco service location; and 3) receiving prior authorization from Newco that the defective equipment is under warranty.

THE FOREGOING WARRANTY IS EXCLUSIVE AND IS IN LIEU OF ANY OTHER WARRANTY, WRITTEN OR ORAL, EXPRESS OR IMPLIED, INCLUDING, BUT NOT LIMITED TO, ANY IMPLIED WARRANTY OF EITHER MERCHANTABILITY OR FITNESS FOR A PARTICULAR PURPOSE. The agents, dealers or employees of Newco are not authorized to make modifications to this warranty or to make additional warranties that are binding on Newco. Accordingly, statements by such individuals, whether oral or written, do not constitute warranties and should not be relied upon.

If Newco determines in its sole discretion that the equipment does not conform to the warranty, Newco, at its exclusive option while the equipment is under warranty, shall either 1) provide at no charge replacement parts and/or labor (during the applicable parts and labor warranty periods specified above) to repair the defective components, provided that this repair is done by a Newco Authorized Service Representative; or 2) shall replace the equipment or refund the purchase price for the equipment.

THE BUYER'S REMEDY AGAINST NEWCO FOR THE BREACH OF ANY OBLIGATION ARISING OUT OF THE SALE OF THIS EQUIPMENT, WHETHER DERIVED FROM WARRANTY OR OTHERWISE, SHALL BE LIMITED, AT NEWCO'S SOLE OPTION AS SPECIFIED HEREIN, TO REPAIR, REPLACEMENT OR REFUND.

In no event shall Newco be liable for any other damage or loss, including, but not limited to, lost profits, lost sales, loss of use of equipment, claims of Buyer's customers, cost of capital, cost of down time, cost of substitute equipment, facilities or services, or any other special, incidental or consequential damages.

SERVICING YOUR MACHINE

DRAINING THE WATER

Caution:

Turn machine off and allow it to cool completely before draining.

Waste bin is designed to hold the water released by the system once all spent pods have been removed.

Always use caution when working with hot water.

1. Once machine has cooled, remove the waste bin.
2. Locate the drain plug behind the waste bin in the lower right corner of the back wall.
3. Pull the plug, the drain tube will come with it.
 - a. You may need to wiggle the tube to fully extend it, as the tube clamp needs to be angled to maneuver it through the drain plug opening.
4. Remove the drain plug from the end of the drain tube
5. Ensure your hands are away from the end of the tube, and aim it into a container or drain.
6. Slide the tube clamp to release the water.
7. Once the water has finished draining, slide the clamp back to close off the drain tube. Then, insert the drain plug onto the end of the drain tube.
8. Push the drain tube back into the machine, and push the drain plug back into its opening.



FLAVOR RING INSTRUCTIONS

For Little Joe Spray Head Assembly

WARNING: *Unplug machine power and read through all instructions carefully before servicing your machine.*

For optimal brewing performance, please keep the flavor ring installed. If there are occurrences of heavier gram weight pods remaining in the upper chamber, then the flavor ring may be removed.

REMOVING THE RING

1. Ensure brewer has fully cooled.
2. Open the brew mech, then pull the flavor ring out of the silicone gasket.
3. Ensure the flavor ring is clean and dry before storing.



REPLACING THE RING

1. Ensure brewer has fully cooled.
2. Open the brew mech, then remove 5 screws holding the spray head assembly in place.

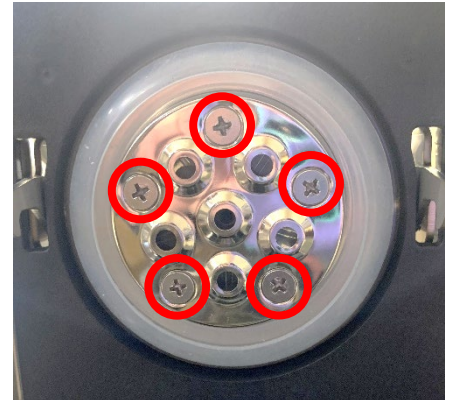

3. Gently pull on the silicone gasket to remove the spray head assembly from brew mech.

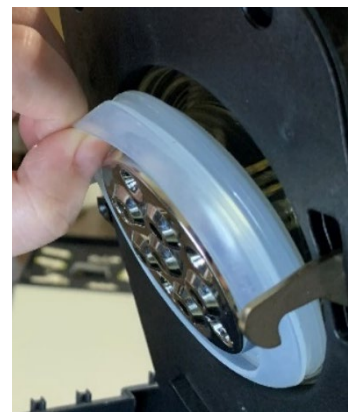

4. Remove the silicone gasket from the silver metal spray head.



5. Align the silver metal spray head and the flavor ring as shown.



6. Insert the flat edges of the silver metal spray head and the flavor ring into the groove of the silicone gasket. Ensure the wider end of the flavor ring is on the same side as the wider groove in the silicone gasket.

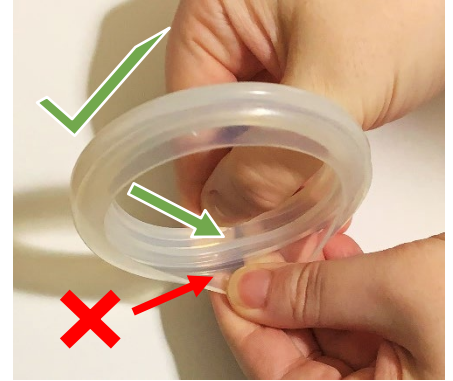

7. Work the silicone gasket around the silver metal spray head and flavor ring until all edges are fully seated in the groove.



8. Identify where the screw holes are on the clear plastic spray head, circled.

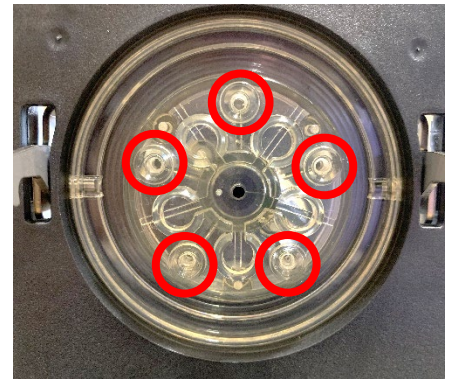

9. Align the screw holes of the clear plastic and the spray head assembly, with the flavor ring facing outwards.

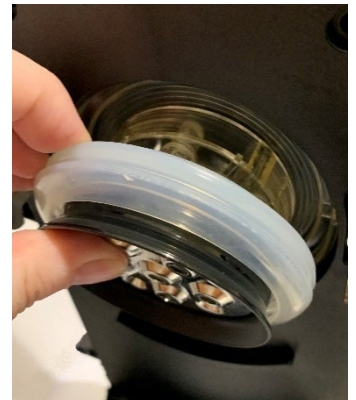

10. Push the spray head assembly into the brew mech and hold while inserting 5 screws.

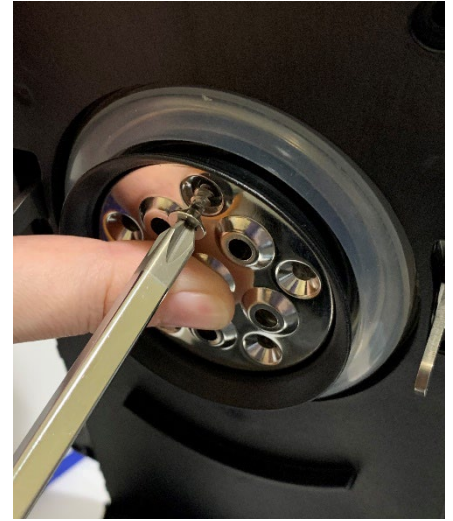

11. Tighten 5 screws, then check to make sure the brew mech closes properly.



Notes:

If the brew mech does not close properly, remove the spray head and start again. Failure to fully tighten screws may cause leakages.

MACHINE PARTS



DISPLAY

**ASSEMBLY
ENGLISH ONLY
PN 153242-SV**

**ASSEMBLY
MULTI-LANGUAGE
PN 153275-SV**

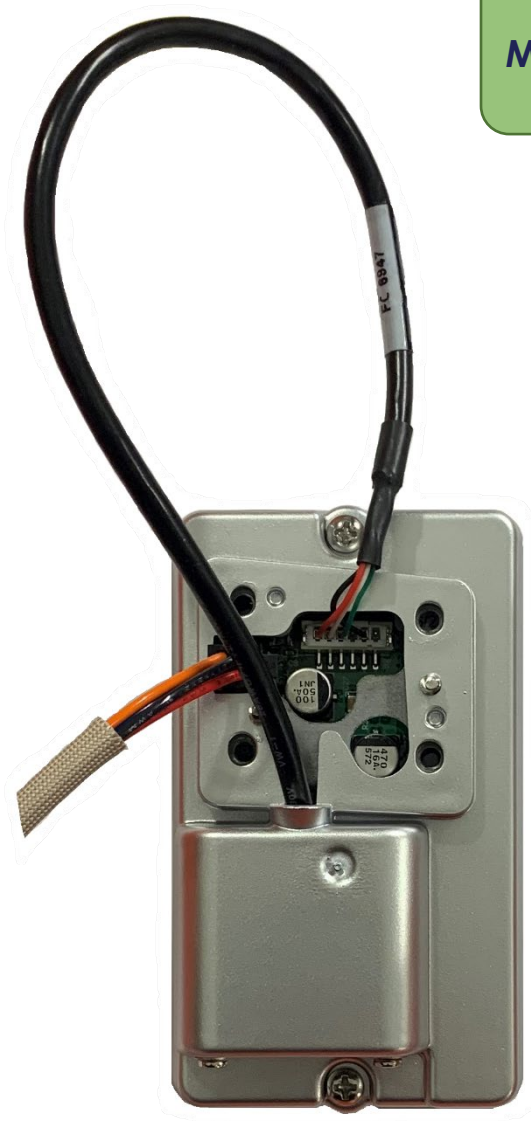

DISPLAY ASSEMBLY WITH PANEL

**ASSEMBLY WITH PANEL
ENGLISH ONLY
PN 153237-SV**

**ASSEMBLY WITH PANEL
MULTI-LANGUAGE
PN 153274-SV**



WASTE BIN

**Assembly
PN 152948**



**Magnet
PN 121301**

**Magnet Cover
PN 782160**

**Pass Through
Waste Bin Assembly
PN 153256**



**Drop Down Cup Holder
PN 152931**

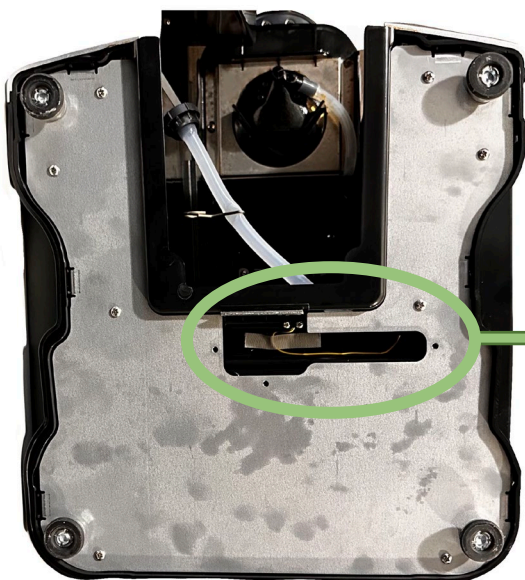

**Waste Bin
Sensor
PN 773043**



DRIP TRAY

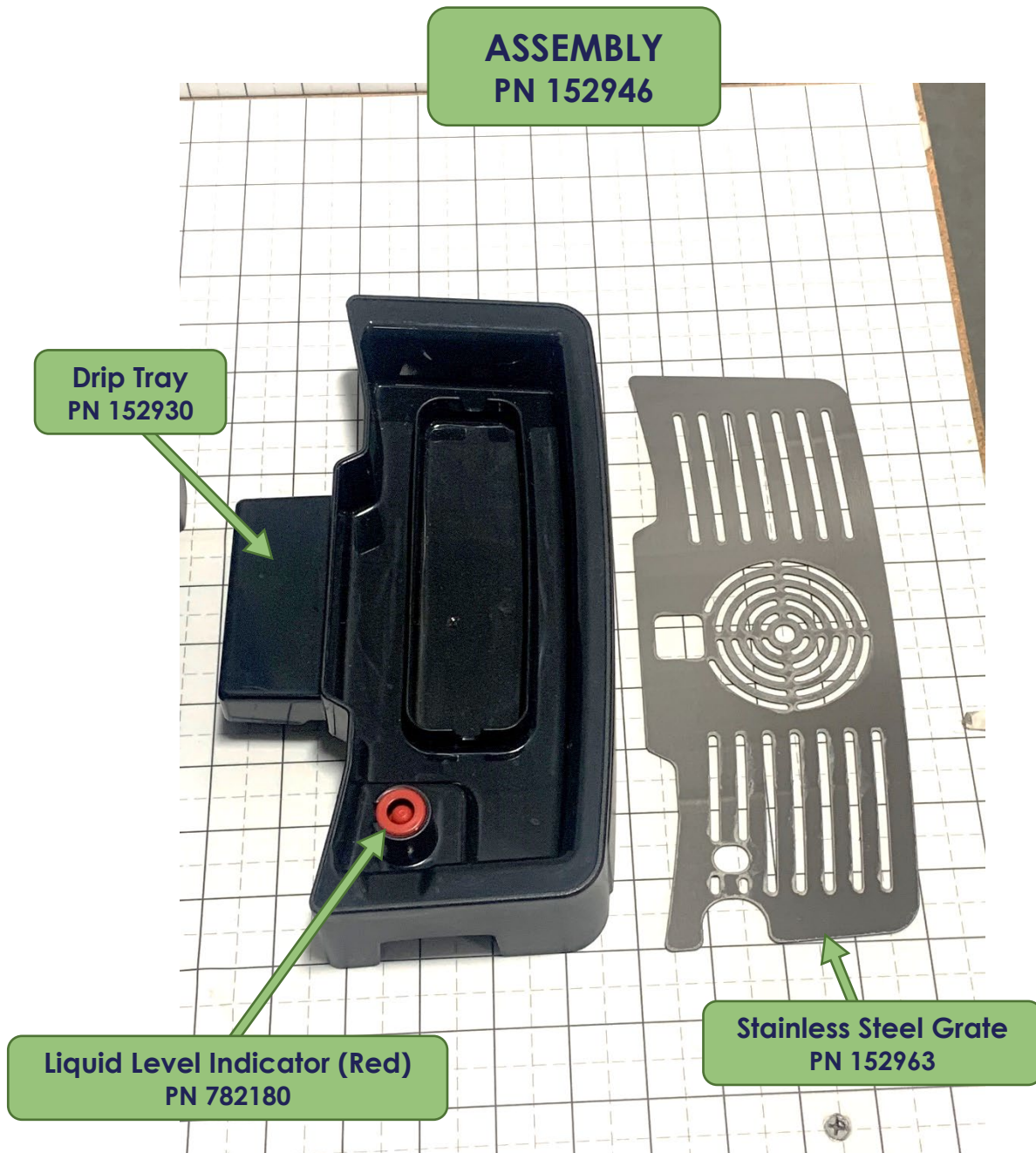

DRAIN TUBE

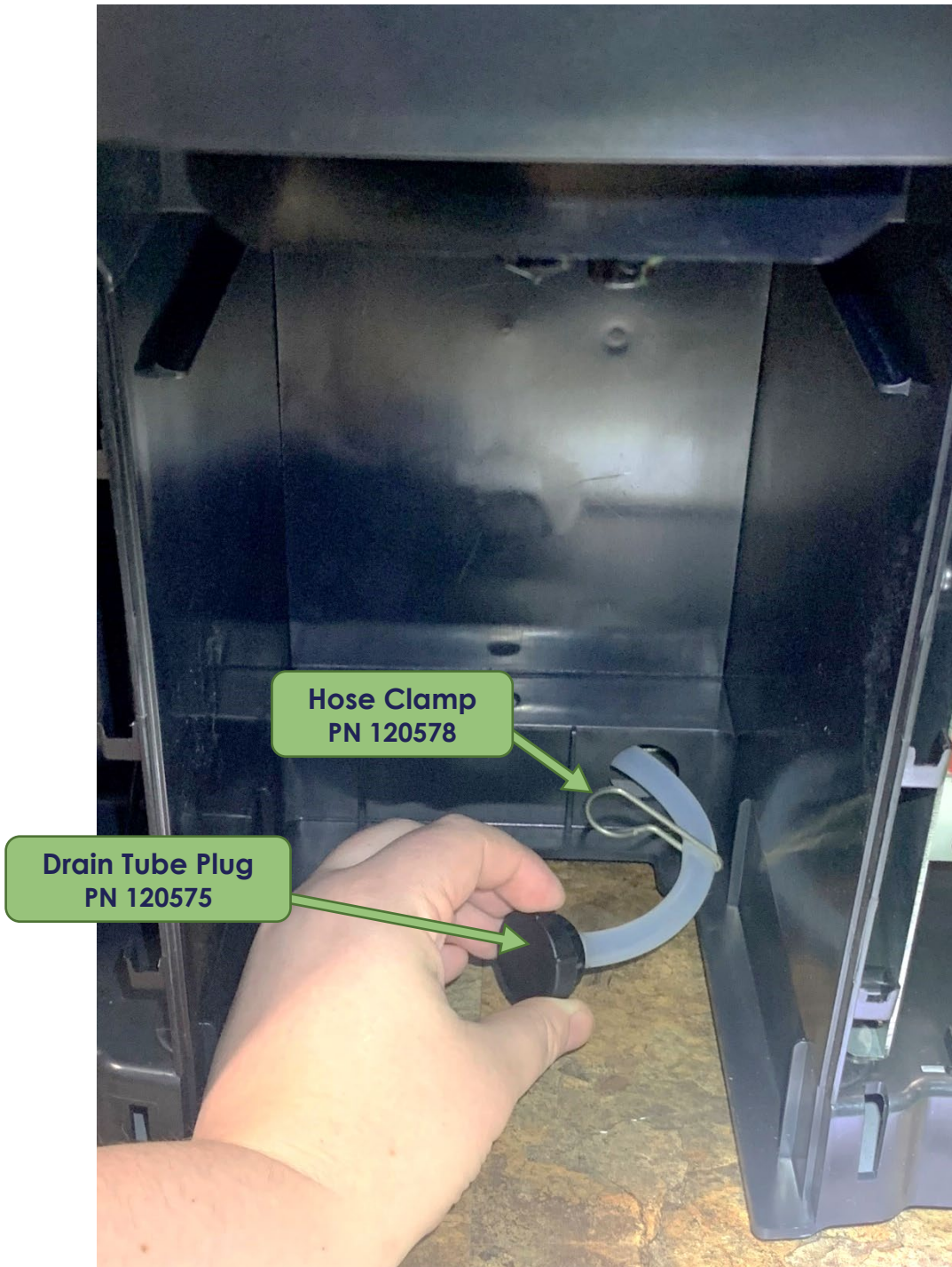

RESERVOIR



BREWING MECHANISM

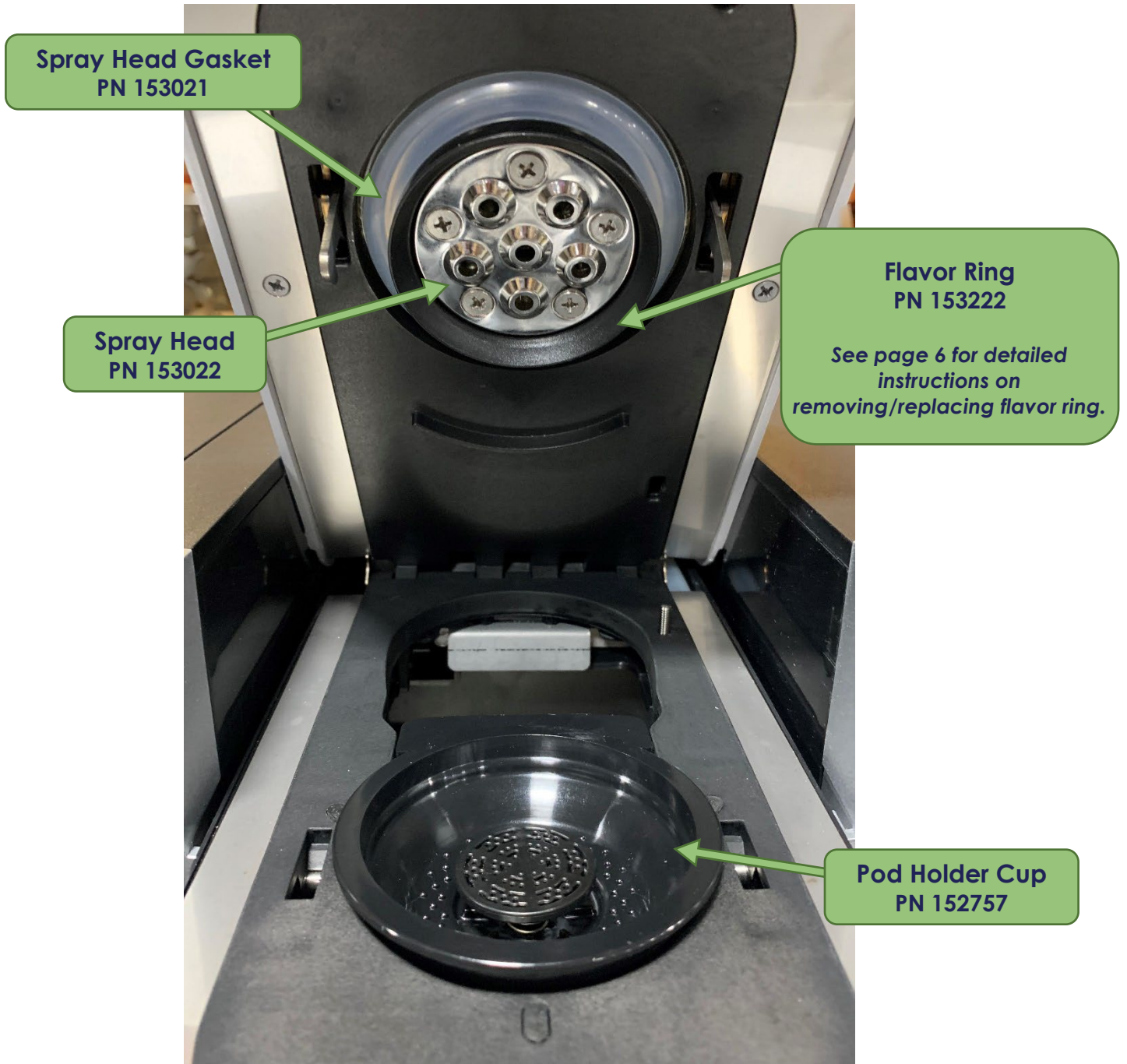

DISPENSE AREA

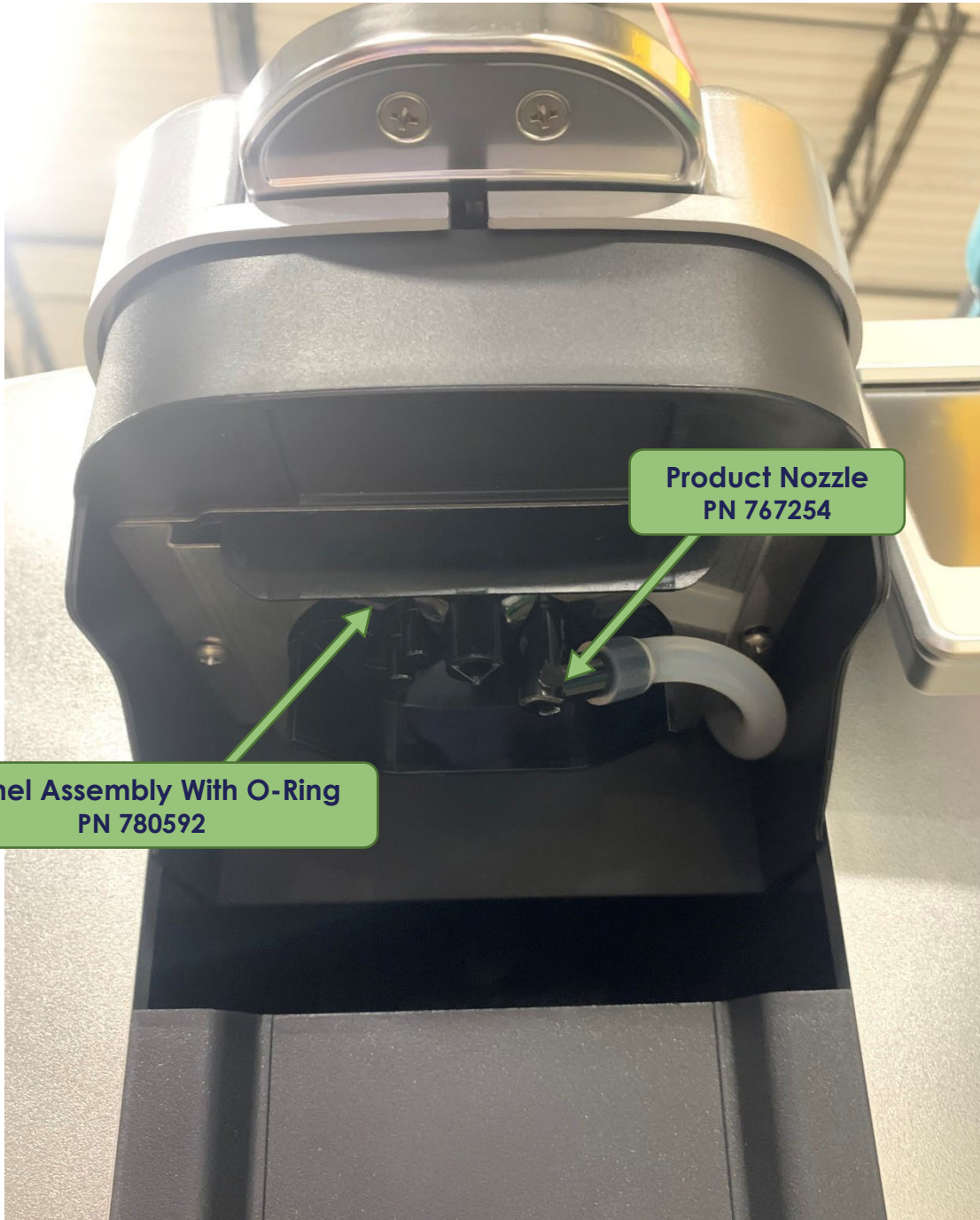

BACK OF THE MACHINE



WATER INLET

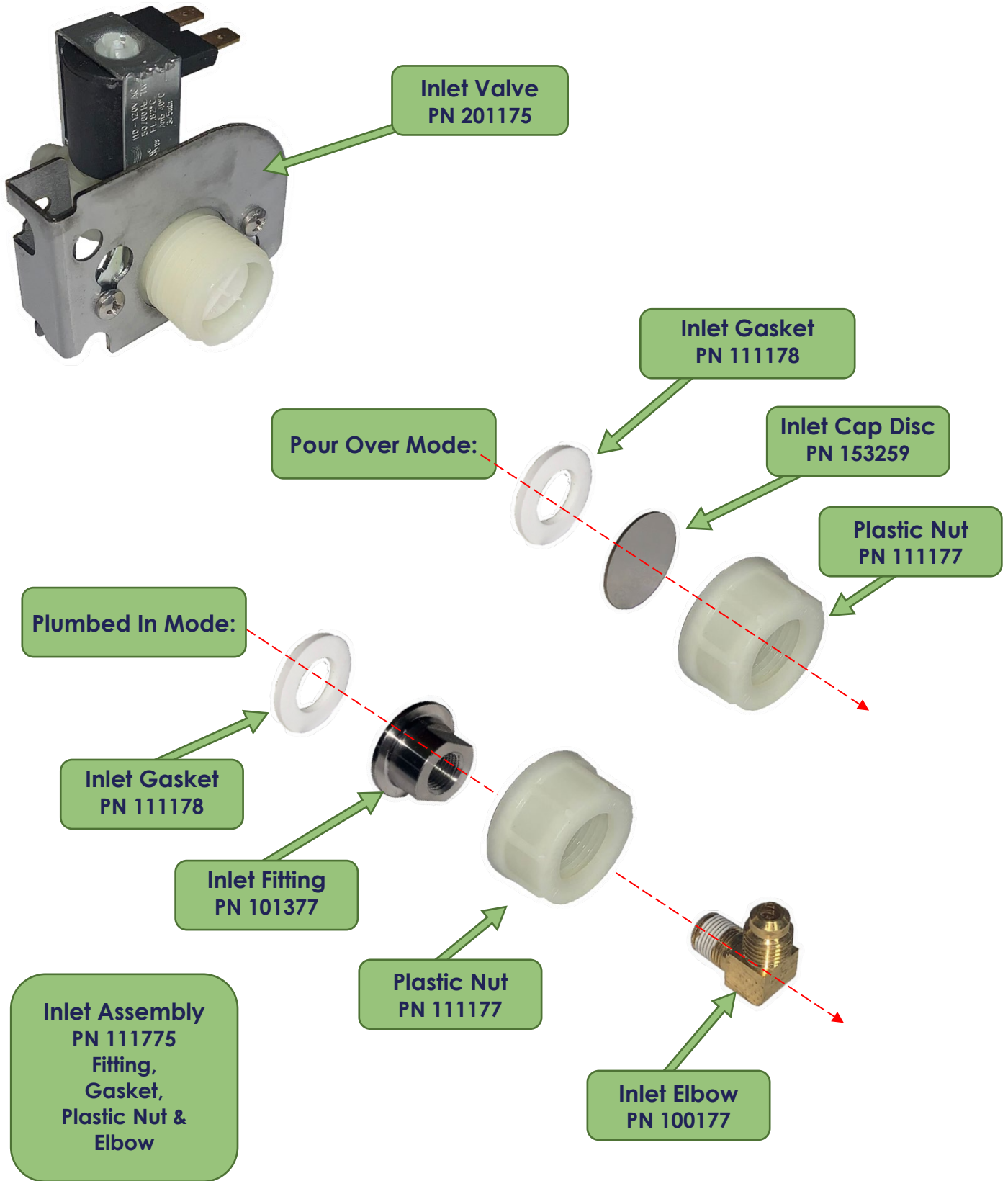

TANK WITH MAJOR COMPONENTS

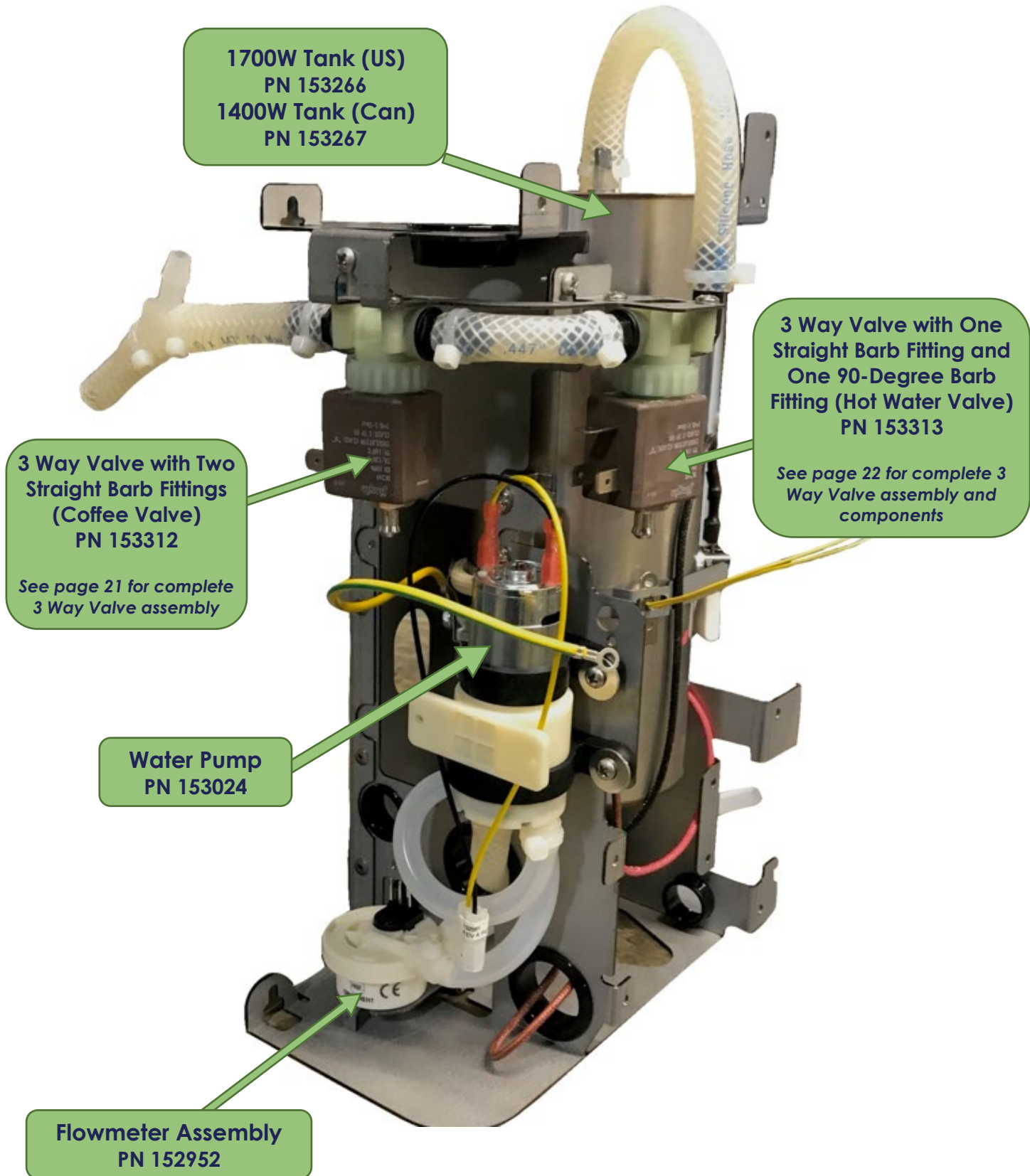

3-WAY VALVE ASSEMBLY COMPONENTS

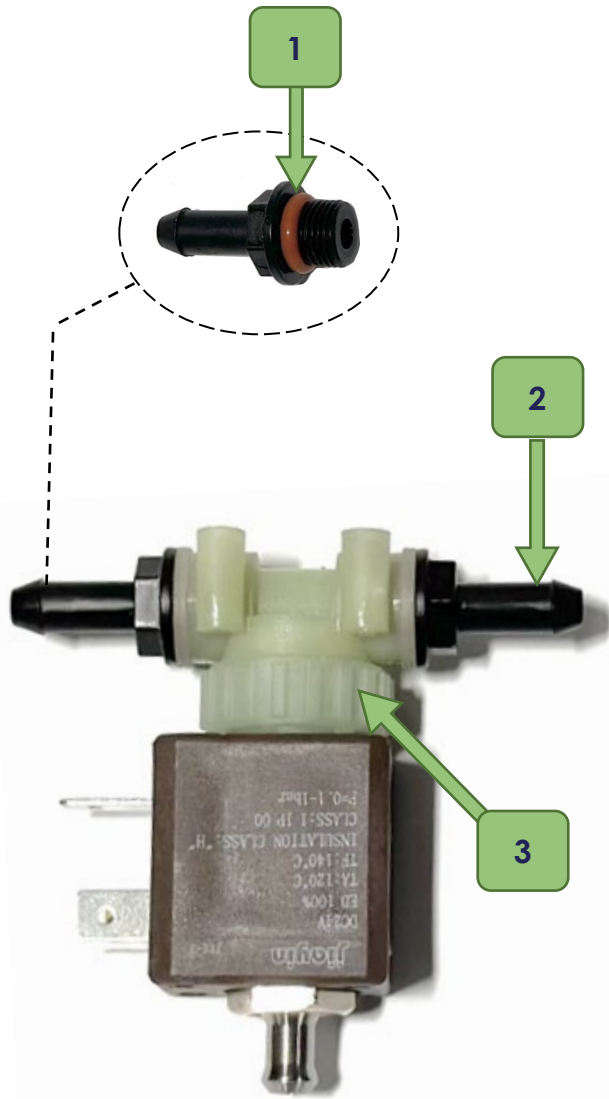

3 Way Valve with Two Straight Barb Fittings

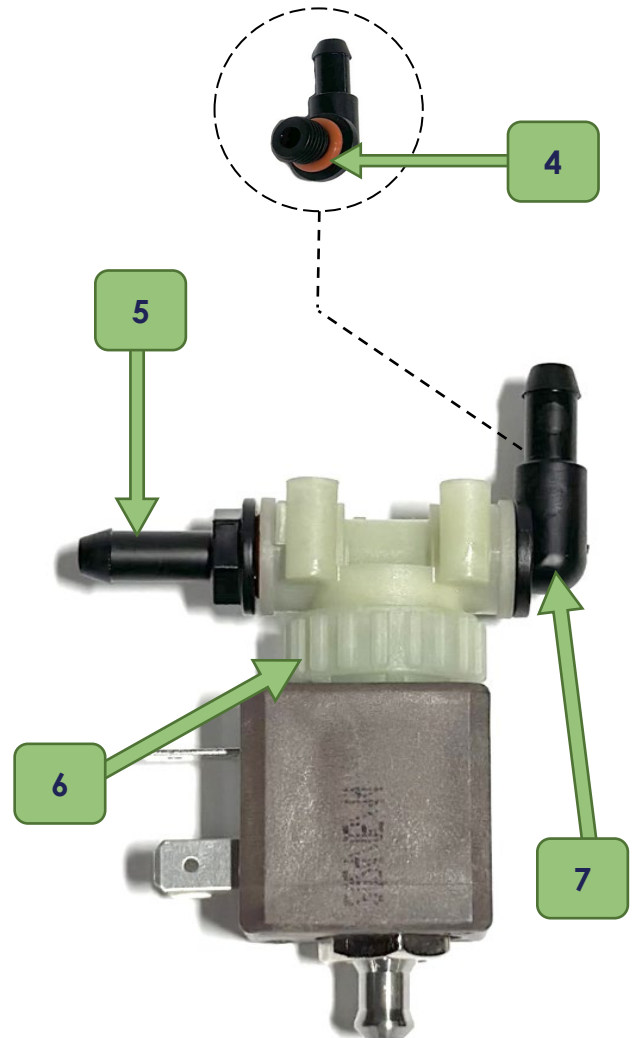

3 Way Valve with One Straight Barb Fitting and One 90-Degree Barb Fitting

	153312	3 Way Valve Assembly with Two	1 EA
1	153215	O-RING, 6MMID, 11MMOD,	2
2	153212	STRAIGHT BARB FITTING, 1/4BARB	2
3	153025	VALVE, 3WAY, LITTLE JOE	1

	153313	3 Way Valve Assembly with	1 EA
4	153215	O-RING, 6MMID, 11MMOD,	2
5	153212	STRAIGHT BARB FITTING,	1
6	153025	VALVE, 3WAY, LITTLE JOE	1
7	153214	90 DEGREE BARB ELBOW,	1

RIGHT SIDE

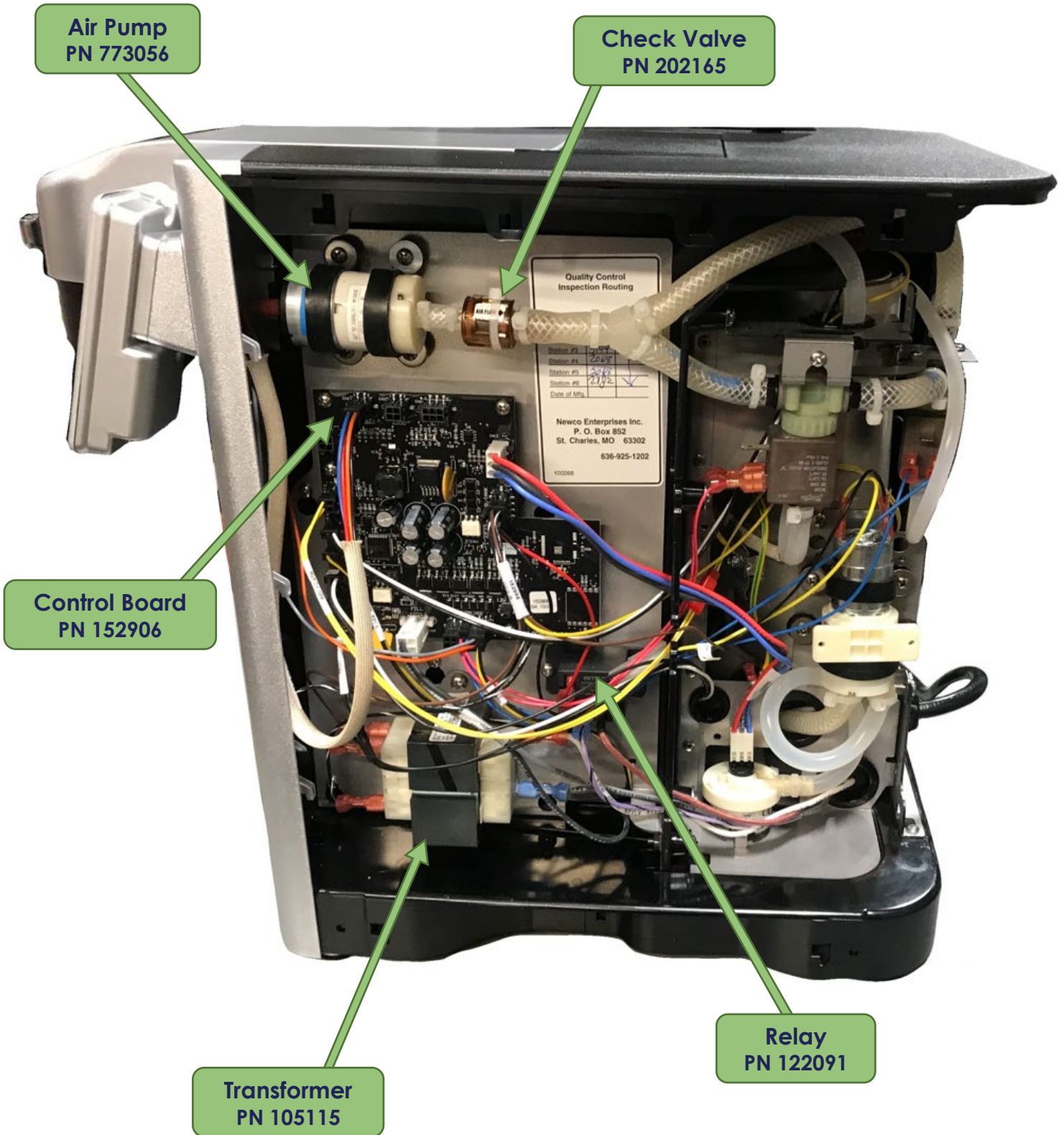

WIRING DIAGRAM

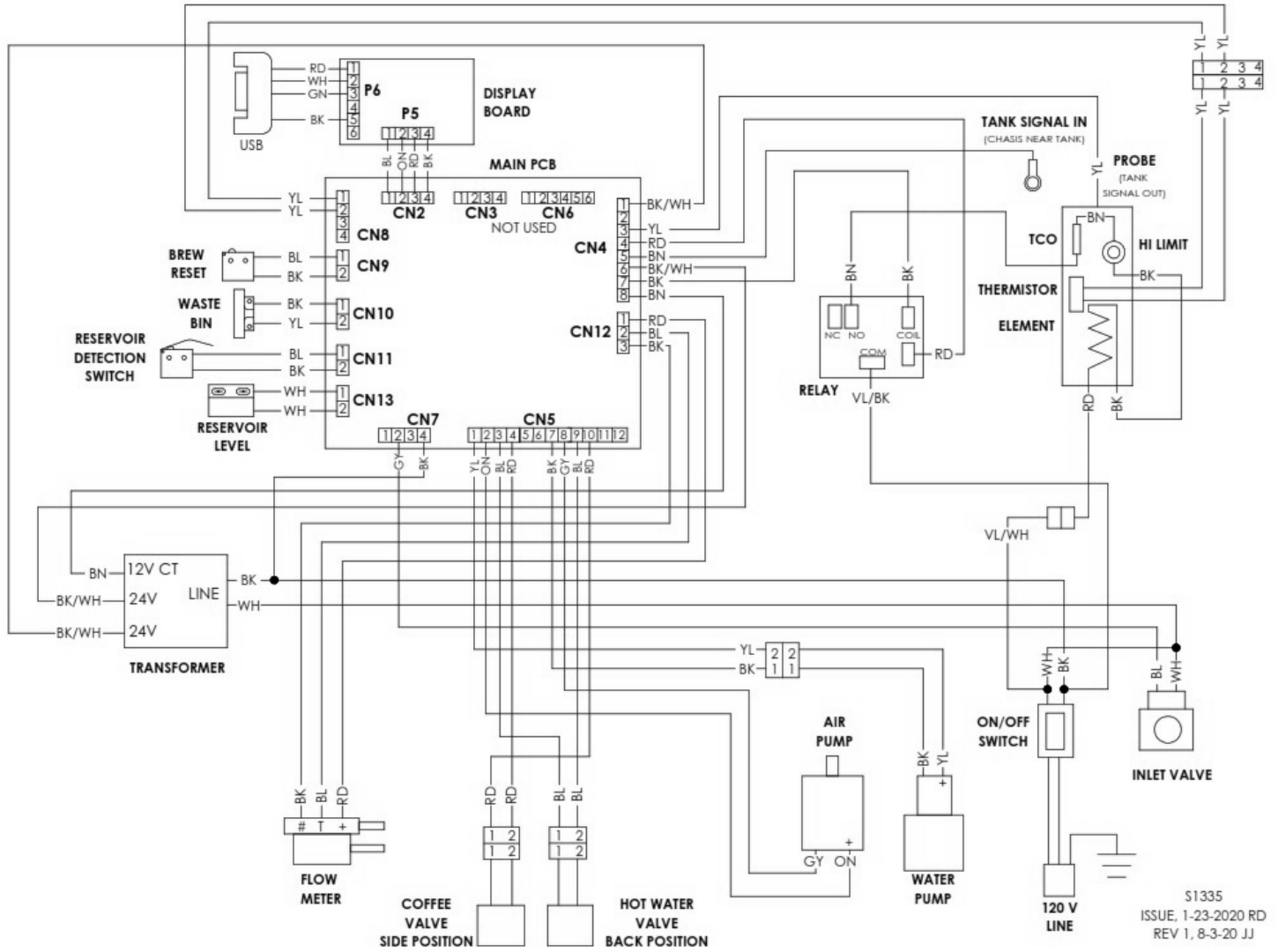

S1335
ISSUE, 1-23-2020 RD
REV 1, 8-3-20 JJ

Page intentionally left blank.